

DENON

DCD-720AE / DCD-520AE
COMPACT DISC PLAYER

Owner's Manual

SAFETY PRECAUTIONS



CAUTION
RISK OF ELECTRIC SHOCK
DO NOT OPEN



CAUTION:
TO REDUCE THE RISK OF ELECTRIC SHOCK, DO NOT REMOVE COVER (OR BACK). NO USER-SERVICEABLE PARTS INSIDE. REFER SERVICING TO QUALIFIED SERVICE PERSONNEL.

The lightning flash with arrowhead symbol, within an equilateral triangle, is intended to alert the user to the presence of uninsulated "dangerous voltage" within the product's enclosure that may be of sufficient magnitude to constitute a risk of electric shock to persons.

The exclamation point within an equilateral triangle is intended to alert the user to the presence of important operating and maintenance (servicing) instructions in the literature accompanying the appliance.

WARNING:
TO REDUCE THE RISK OF FIRE OR ELECTRIC SHOCK, DO NOT EXPOSE THIS APPLIANCE TO RAIN OR MOISTURE.

CLASS 1 LASER PRODUCT

"CLASS 1
LASER PRODUCT"

- ADVARSEL:** USYNLIG LASERSTRÅLING VED ÅBNING, NÅR SIKKERHEDSAFBRYDERE ER UDE AF FUNKTION. UNDGÅ UDSÆTTELSE FOR STRÅLING.
- VAROITUS!** LAITTEEN KÄYTTÄMINEN MUULLA KUIN TÄSSÄ KÄYTTÖOHJEESSA MAINITULLA TAVALLA SAATTAA ALTISTAA KÄYTTÄJÄN TURVALLISUUSLUOKAN 1 YLITTÄVÄLLE NÄKYMÄMTTÖMÄLLE LASERSÄTEILYLLE.
- WARNING:** OM APPARATEN ANVÄNDS PÅ ANNAT SÄTT ÄN I DENNA BRUKSANVISNING SPECIFICERATS, KAN ANVÄNDAREN UTSÄTTAS FÖR OSYNLIG LASERSTRÅLNING SOM ÖVERSKRIDER GRÄNSEN FÖR LASERKLASS 1.



ATTENZIONE: QUESTO APPARECCHIO E' DOTATO DI DISPOSITIVO OTTICO CON RAGGIO LASER. L'USO IMPROPRIO DELL'APPARECCHIO PUO' CAUSARE PERICOLOSE ESPOSIZIONI A RADIAZIONI!

IMPORTANT SAFETY INSTRUCTIONS

1. Read these instructions.
2. Keep these instructions.
3. Heed all warnings.
4. Follow all instructions.
5. Do not use this apparatus near water.
6. Clean only with dry cloth.
7. Do not block any ventilation openings. Install in accordance with the manufacturer's instructions.
8. Do not install near any heat sources such as radiators, heat registers, stoves, or other apparatus (including amplifiers) that produce heat.
9. Protect the power cord from being walked on or pinched particularly at plugs, convenience receptacles, and the point where they exit from the apparatus.
10. Only use attachments/accessories specified by the manufacturer.
11. Use only with the cart, stand, tripod, bracket, or table specified by the manufacturer, or sold with the apparatus. When a cart is used, use caution when moving the cart/apparatus combination to avoid injury from tip-over.
12. Unplug this apparatus during lightning storms or when unused for long periods of time.
13. Refer all servicing to qualified service personnel. Servicing is required when the apparatus has been damaged in any way, such as power-supply cord or plug is damaged, liquid has been spilled or objects have fallen into the apparatus, the apparatus has been exposed to rain or moisture, does not operate normally, or has been dropped.
14. Batteries shall not be exposed to excessive heat such as sunshine, fire or the like.



CAUTION:

To completely disconnect this product from the mains, disconnect the plug from the wall socket outlet.
The mains plug is used to completely interrupt the power supply to the unit and must be within easy access by the user.

• DECLARATION OF CONFORMITY

We declare under our sole responsibility that this product, to which this declaration relates, is in conformity with the following standards: EN60065, EN55013, EN55020, EN61000-3-2 and EN61000-3-3. Following the provisions of Low Voltage Directive 2006/95/EC and EMC Directive 2004/108/EC, the EC regulation 1275/2008 and its frame work Directive 2009/125/EC for Energy-related Products (ErP).

DENON EUROPE
Division of D&M Germany GmbH
An der Kleinbahn 18, Nettetal,
D-41334 Germany

A NOTE ABOUT RECYCLING:

This product's packaging materials are recyclable and can be reused. Please dispose of any materials in accordance with the local recycling regulations.

When discarding the unit, comply with local rules or regulations.

Batteries should never be thrown away or incinerated but disposed of in accordance with the local regulations concerning battery disposal.

This product and the supplied accessories, excluding the batteries, constitute the applicable product according to the WEEE directive.



Pb

CAUTION:

USE OF CONTROLS OR ADJUSTMENTS OR PERFORMANCE OF PROCEDURES OTHER THAN THOSE SPECIFIED HEREIN MAY RESULT IN HAZARDOUS RADIATION EXPOSURE. THIS PRODUCT SHOULD NOT BE ADJUSTED OR REPAIRED BY ANYONE EXCEPT PROPERLY QUALIFIED SERVICE PERSONNEL.

❑ NOTES ON USE

WARNINGS

- Avoid high temperatures.
Allow for sufficient heat dispersion when installed in a rack.
- Handle the power cord carefully.
Hold the plug when unplugging the cord.
- Keep the unit free from moisture, water, and dust.
- Unplug the power cord when not using the unit for long periods of time.
- Do not obstruct the ventilation holes.
- Do not let foreign objects into the unit.
- Do not let insecticides, benzene, and thinner come in contact with the unit.
- Never disassemble or modify the unit in any way.
- Ventilation should not be impeded by covering the ventilation openings with items, such as newspapers, tablecloths or curtains.
- Naked flame sources such as lighted candles should not be placed on the unit.
- Observe and follow local regulations regarding battery disposal.
- Do not expose the unit to dripping or splashing fluids.
- Do not place objects filled with liquids, such as vases, on the unit.
- Do not handle the mains cord with wet hands.
- When the switch is in the OFF (STANDBY) position, the equipment is not completely switched off from MAINS.
- The equipment shall be installed near the power supply so that the power supply is easily accessible.
- Do not keep the battery in a place exposed to direct sunlight or in places with extremely high temperatures, such as near a heater.

❑ CAUTIONS ON INSTALLATION

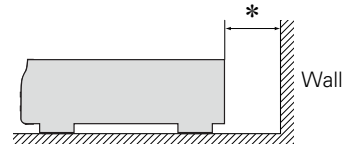
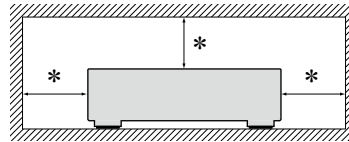

*** For proper heat dispersal, do not install this unit in a confined space, such as a bookcase or similar enclosure.**

- More than 0.1 m is recommended.
- Do not place any other equipment on this unit.

Getting started

Thank you for purchasing this DENON product. To ensure proper operation, please read this owner's manual carefully before using the product. After reading them, be sure to keep them for future reference.

Contents

Getting started	1
Accessories	1
Features	2
Cautions on handling	2

Preparations

Connections	4
Cables used for connections	4
Connecting a 2-channel audio amplifier	4
Connecting to a digital recording device	4
Connecting an iPod or USB memory device to the iPod/USB port (DCD-720AE only)	5
Connecting the power cord	6
Setting the Auto Standby mode	6

Operations

Playback	8
Turning the power on	8
Playing CD	8
Playback of MP3 and WMA files	9
Playback iPod®	10
Playing a USB memory device	11
Operations enabled during playback	12
Using the timer play function	14

Information

Part names and functions	16
Front panel	16
Display	17
Rear panel	17
Remote control unit	18
Other information	21
Playable media	21
Cautions on using media	23
Explanation of terms	24
Troubleshooting	25
Specifications	26

Accessories

Check that the following parts are supplied with the product.

① Getting Started	1
② CD-ROM (Owner's manual)	1
③ Safety Instructions	1
④ Service network list	1
⑤ Remote control unit (RC-1173)	1
⑥ R03/AAA batteries	2
⑦ Audio cable	1

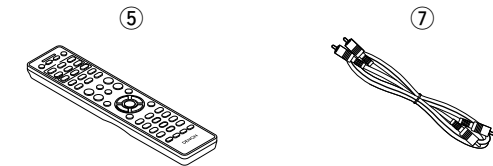

Features

AL32 Processing (DCD-720AE only)

Equipped with AL32 Processing, DENON's own analog waveform reproduction technology.

The reproducibility of weak signals is enhanced by expanding 16 bit digital data to 32 bit.

High precision 32 bit / 192 kHz D/A converter

Equipped with high-precision 32 bit / 192 kHz-compatible D/A converter for analog signal conversion of the digital data (in the case of DCD-720AE, expanded with AL32 processing).

USB and iPod Direct playback

A USB port is mounted on the Front Panel. MP3/WMA files can be played by connecting a USB Player or USB memory device.

An iPod is connected using the USB cable supplied with the iPod. Music files in an iPod, USB Player or USB memory device are transmitted via digital signal and can be enjoyed at high audio quality using the this unit's own audio circuitry.

Large 16-character / 2-line display

Text information appears on the large display during MP3 or iPod playback.

Reduced power consumption during standby

In consideration of the environment, power consumption during standby has been reduced to 0.3 W or better.

Cautions on handling

• Before turning the power on

Check once again that all connections are correct and that there are no problems with the connection cables.

- Power is supplied to some of the circuitry even when the unit is set to the standby mode. When going on vacation or leaving home for long periods of time, be sure to unplug the power cord from the power outlet.

• Proper ventilation

If the unit is left in a room full of the smoke from cigarettes, etc., for long periods of time, the surface of the optical pickup may get dirty, preventing it from receiving the signals properly.

• About condensation

If there is a major difference in temperature between the inside of the unit and the surroundings, condensation (dew) may form on the operating parts inside the unit, causing the unit not to operate properly.

If this happens, let the unit sit for an hour or two with the power turned off and wait until there is little difference in temperature before using the unit.

• Cautions on using mobile phones

Using a mobile phone near this unit may result in noise. If that occurs, move the mobile phone away from this unit when it is in use.

• Moving the unit

Turn off the power and unplug the power cord from the power outlet. Next, disconnect the connection cables to other system units before moving the unit.

• About care

- Wipe the cabinet and control panel clean with a soft cloth.
- Follow the instructions when using a chemical cleaner.
- Benzene, paint thinner or other organic solvents as well as insecticide may cause material changes and discoloration if brought into contact with the unit, and should therefore not be used.

Preparations

Here, we explain the connections and setup methods for this unit.

- **Connections**  [page 4](#)
- **Setting the Auto Standby mode**  [page 6](#)

Connections



Connections for all compatible audio signal formats are described in this owner's manual. Please select the type of connections corresponding to the equipment you are connecting.

NOTE

- Do not plug in the power cord until all connections have been completed.
- When making connections, also refer to the owner's manual of the other components.
- Be sure to connect the left and right channels properly (left with left, right with right).
- Do not bundle power cords together with connection cables. Doing so can result in humming or noise.

Cables used for connections

Select the cables according to the equipment being connected.

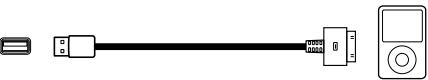
Audio cable (supplied)	
Audio cable	
Audio cable (sold separately)	
Optical cable	
Cable (sold separately)	
USB cable (Provided with iPod)	

Connecting a 2-channel audio amplifier

This connection is for playback of audio of this unit, using a 2-channel audio device.

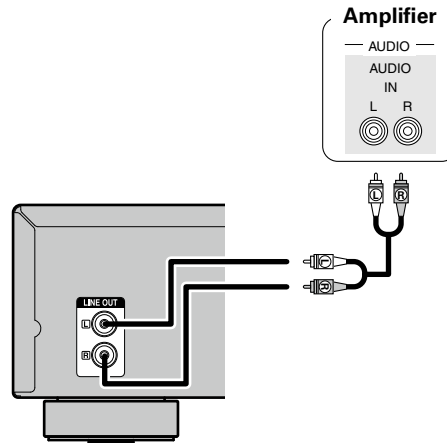

Connecting to a digital recording device

This connection is for recording audio from this unit, using an audio device with optical digital audio input connectors.

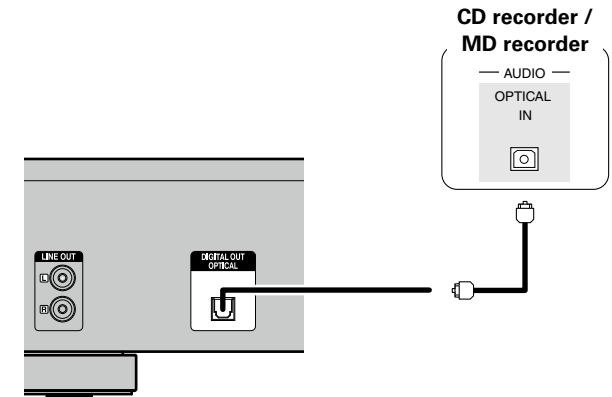

❑ When connecting the optical digital output connector with an optical transmission cable (sold separately)

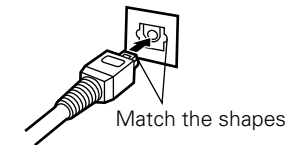

Match the shapes then insert firmly.

Connecting an iPod or USB memory device to the iPod/USB port (DCD-720AE only)

- You can enjoy music stored on an iPod or USB memory device.
- For operating instructions see “Playback iPod®” (page 10) or “Playing a USB memory device” (page 11).

Cables used for connections

To connect an iPod to this unit, use the USB cable supplied with the iPod.

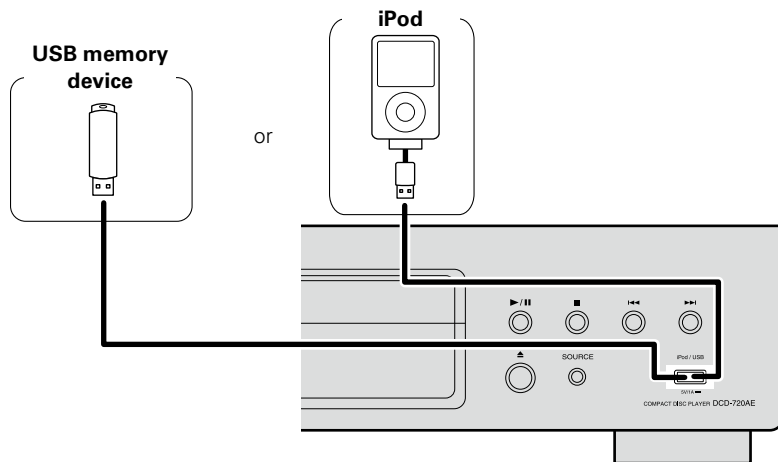

DENON does not guarantee that all USB memory devices will operate or receive power. When using a portable USB connection type HDD of the kind to which an AC adapter can be connected to supply power, use the AC adapter.

NOTE

- USB memory devices will not work via a USB hub.
- It is not possible to use this unit by connecting the unit's iPod/USB port to a PC via a USB cable.
- Do not use an extension cable when connecting a USB memory device. This may cause radio interference with other devices.
- When connecting an iPhone to this unit, keep the iPhone at least 20 cm away from this unit. If the iPhone is kept closer to this unit and a telephone call is received by the iPhone, noise may be output from this device.
- If the iPod is connected using an iPod cable (commercially available) that is longer than 2 m, sound may not be played correctly. In this case, use a genuine iPod cable, or a cable that is shorter than 1 m.

Supported iPod models

• iPod classic



iPod classic
80GB



iPod classic
160GB (2007)



iPod classic
160GB (2009)

• iPod nano



iPod nano
3rd generation
(video)
4GB 8GB



iPod nano
4th generation (video)
8GB 16GB



iPod nano
5th generation (video camera)
8GB 16GB



iPod nano
6th generation
8GB 16GB

• iPod touch



iPod touch
1st generation
8GB 16GB 32GB



iPod touch
2nd generation
8GB 16GB 32GB



iPod touch
3rd generation
32GB 64GB



iPod touch
4th generation
8GB 32GB 64GB

• iPhone



iPhone
4GB 8GB 16GB



iPhone 3G
8GB 16GB



iPhone 3GS
8GB 16GB 32GB



iPhone 4
8GB 16GB 32GB



iPhone 4S
16GB 32GB 64GB

(as of May 2012)

Connecting the power cord

After completing all the connections, insert the power plug into the power outlet.

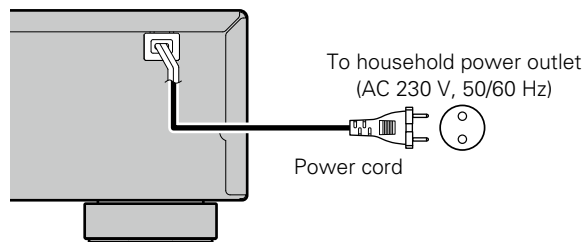

NOTE

- Do not plug in the power cord until all connections have been completed.
- Insert the plugs securely. Loose connections will result in the generation of noise.
- Do not unplug the power cord while the unit is operating.

Setting the Auto Standby mode



With the Auto Standby ON, this unit will automatically enter the standby mode after about 30 continuous minutes of stop mode with no operation.

- The default setting is "On".

Press and hold **POWER** for at least 5 seconds.

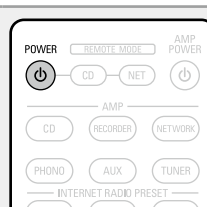
- Auto Standby mode is switched between Off and On.
- The power indicator indicates Auto Standby mode Off/On during Standby, as shown below :



Auto Standby mode "Off"  "Lit in red" ↔ Auto Standby mode "On"  "Unlit"

- The power indicator flashes in red during Auto Standby mode setting.



- If you set the Auto Standby mode while the unit is ON, the unit will enter the standby mode as soon as the Auto Standby mode setting is completed.
- When iPod is being charged, this unit enters the power standby mode after charging.

NOTE

If an iPod is connected with this unit in the remote mode, this unit will not enter the standby mode, even after about 30 continuous minutes of stop mode with no operation.

Operations

Here, we explain functions and operations that let you make better use of this unit.

● Playback  [page 8](#)

Playback

Turning the power on

Before using a remote control unit, insert the batteries (🔗 [page 20](#) "Inserting the batteries").

Press **POWER**  to turn on power to the unit.

- The power indicator lights green and the power turns on.

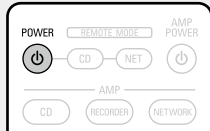

- The "NO DISC" message is displayed if a disc is not loaded.

When power is switched to standby

Press **POWER** .

The power is set to the standby mode.

[Power indicator status]

- Normal standby : Red
- Auto standby mode : Off
- Charge mode standby : Orange

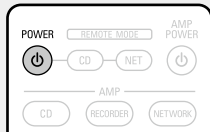

Turning the power off

Press  on the main unit.

- The power indicator turns off, and so does the power.



- Be sure to stop playback before turning the power off.
- Make sure that the disc tray is completely shut before turning off the power.

NOTE

Power continues to be supplied to some of the circuitry even when the power is in the standby mode. When leaving home for long periods of time or when going on vacation, either press  on the unit to turn off the power, or unplug the power cord from the power outlet.

Playing CD

1 Press **POWER**  to turn on power to the unit.

2 Press **SOURCE** to set the playback media mode to "DISC".

3 Press  on the unit to open the disc tray and insert the disc.

4 Press .

- The  indicator lights.
- The disc tray closes and playback starts.

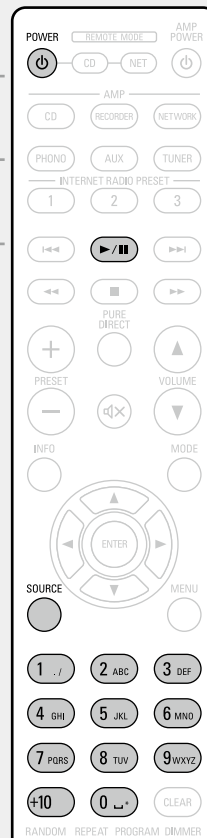

Playing a specific track

Press **0 – 9** and **+10** to select the track.

[Example] : Track 4 : Press **4**.

[Example] : Track 12 : Press **+10** and **2**.

Operations enabled during playback

(🔗 [page 12](#))

NOTE

Do not place any foreign objects in the disc tray. Doing so could damage it.

Playback of MP3 and WMA files

There are many music distribution sites on the Internet allowing you to download music files in MP3 or WMA (Windows Media® Audio) formats. The music (files) downloaded from such sites can be stored on CD-R or CD-RW discs and played on the unit.

“Windows Media” and “Windows” are registered trademarks or trademarks of Microsoft Corporation in the United States and other countries.

Playing MP3 and WMA files

1 Press **POWER** to turn on power to the unit.

2 Load a CD-R or CD-RW disc containing music files in the MP3 or WMA formats into the disc tray.

3 Press **MODE** to select the folder mode or disc mode.

□ About the display

• When “Folder mode” is selected

“FLD” indicator lights. All the files in the selected folder are played.

• When “Disc mode” is selected

“FLD” indicator turns off. After the selected folder and files are played, all the files in all the folders are played.

4 Use $\Delta \nabla$ to select the folder to be played.

5 Use $\lll, \ggg, \triangleleft$ or \triangleright to select the file to be played.

6 Press **▶/||**. Playback starts.



□ To switch the folder or file during playback

• Folder

Use $\Delta \nabla$ to select the folder, and then press **ENTER**.

• File

Use $\triangleleft \triangleright$ to select the file, then press **ENTER**.

Also use \lll, \ggg to select the file, or use **0-9, +10** to select the file number.

• The file numbers are set automatically when the disc is loaded.



Copyright-protected files cannot be played.

(The “Not Support” is displayed.)

Note that depending on the software used for burning and other conditions, some files may not play or display correctly.

□ Switching the display

During playback, press **INFO**.



• The player can display the following characters:

ABCDEFGHIJKLMNOPQRSTUVWXYZ
 abcdefghijklmnopqrstuvwxyz
 0123456789
 ! " # \$ % & ; : < > ? @ [] _ ` | { } ~ ^ ' () * + , - . / = (space)

□ Repeat playback

Press **REPEAT**.

Playback starts in the respective repeat mode.

• The selectable repeat modes differ in the “Folder mode” and the “Disc mode”.

When “Folder mode” is selected

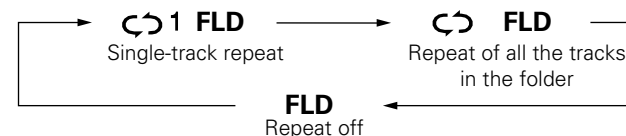

1 FLD Only the selected track is played repeatedly.

FLD All the files in the selected folder are played repeatedly.

Repeat off Folder mode playback resumes.

When “Disc mode” is selected

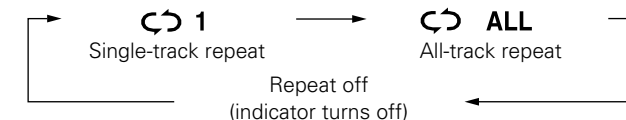

1 Only the selected track is played repeatedly.

ALL All the files in the selected folder are played repeatedly.

Repeat off Folder mode playback resumes.

□ Operations enabled during playback

([page 12](#))

NOTE

Programmed playback is not possible with MP3/WMA discs.

Playback iPod®

With the unit, you can listen to music on an iPod and you can also operate the iPod with the main unit or the remote control unit.



“Made for iPod” means that an electronic accessory has been designed to connect specifically to iPod and has been certified by the developer to meet Apple performance standards.

Apple is not responsible for the operation of this device or its compliance with safety and regulatory standards.

iPod is a trademark of Apple Inc., registered in the U.S. and other countries.

- The iPod may only be used to copy or play contents that are not copyrighted or contents for which copying or playback is legally permitted for your private use as an individual. Be sure to comply with applicable copyright laws.

Playing iPod®

1 Press **POWER** to turn on power to the unit.

2 Press **MODE** to select the display mode.
The mode switches each time the button is pressed.

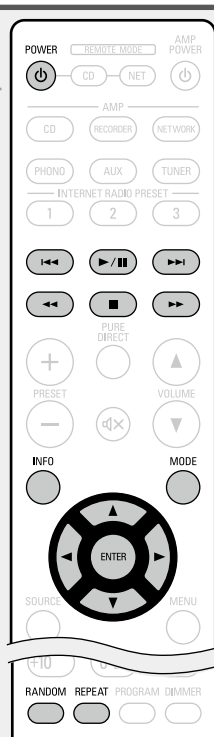

Display mode		Browse mode	Remote mode
Display location		Main unit display	iPod display
Playable files	Audio file	✓	✓
	Video file		✓
Active buttons	Remote control unit (This unit)	✓	✓
	iPod		✓

3 Use Δ / ∇ to select the item, then press **ENTER** or \triangleright to select the music file to be played.

4 Press \blacktriangleright /**II**.
Playback starts.

Disconnecting the iPod

- 1 Press \blacksquare .
- 2 Disconnect the USB cable from the iPod/USB port.

To switch the display (Browse mode only)

During playback, press **INFO**.

- The display switches each time the button is pressed.



Remote control unit and iPod button relations

Remote control unit buttons	iPod buttons	Operation on the main unit
\blacktriangleright / II	\blacktriangleright / II	Plays the track • Play/Pause in remote mode
\blacktriangleleft , \blacktriangleright	\blacktriangleleft , \blacktriangleright	Plays the track from the beginning / Plays the next track
\blacktriangleleft , \blacktriangleright (Press and hold)	\blacktriangleleft , \blacktriangleright (Press and hold)	Fast-reverses the track / Fast-forwards the track
\blacktriangleleft , \blacktriangleright		
Δ / ∇	Click Wheel	Selects an item
\triangleleft	MENU	Displays the menu or return to the previous menu
\triangleright or ENTER	Select	Enters the selection or plays the track
MODE	-	Switches between the browse mode and the remote mode
RANDOM	-	Switches the shuffle function
REPEAT	-	Switches the repeat function

Operations enabled during playback

([page 12](#))

NOTE

- DENON will accept no responsibility whatsoever for any loss of iPod data.
- Depending on the type of iPod and the software version, some functions may not operate.

Playing a USB memory device

Playing files stored on USB memory device

1 Press **POWER** to turn on power to the unit.

2 Press **SOURCE** to set the playback media mode to “USB”.

3 Press **MODE** to select the folder mode or disc mode.

About the display

• **When “Folder mode” is selected**

“FLD” indicator lights.
All the files in the selected folder are played.

• **When “Disc mode” is selected**

“FLD” indicator turns off.
After the selected folder and files are played, all the files in all the folders are played.

4 Use $\Delta \nabla$ to select the folder to be played.

5 Use \leftarrow , \rightarrow , \triangleleft or \triangleright to select the file to be played.

6 Press \blacktriangleright / \parallel .
Playback starts.



Disconnecting the USB memory device

- ① Press \blacksquare .
- ② Make sure that the communications indicator on the USB memory device is not flashing, and disconnect the USB memory device.

To switch the folder or file during playback

• **Folder**

Use $\Delta \nabla$ to select the folder, then press **ENTER**.

• **File**

Use $\triangleleft \triangleright$ to select the file, then press **ENTER**.

Use $\leftarrow \rightarrow$ or $\blacktriangleleft \blacktriangleright$ to select the file or use **0–9** and **+10** to select the file number.

- The file numbers are set automatically when the USB memory device is loaded.

Switching the display

During playback, press **INFO**.

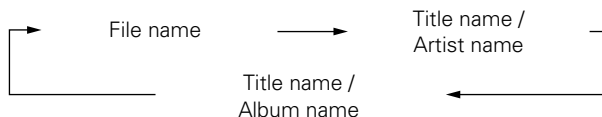

- The player can display the following characters:

ABCDEFGHIJKLMNOPQRSTUVWXYZ
abcdefghijklmnopqrstuvwxyz
0123456789
! " # \$ % & ; : < > ? @ I [] _ ` | { } ~ ^ ' () * + , - . / = (space)

Operations enabled during playback

[page 12](#)



- USB memory devices will not work via a USB hub.
- DENON does not guarantee that all USB memory devices will operate or be supplied power. When using a USB connection type portable hard disk of the type for which power can be supplied by connecting an AC adapter, we recommend using the AC adapter.

NOTE

DENON will take no responsibility whatsoever for any loss or damage to data on a USB memory device when using it connected to the unit.

Operations enabled during playback

Stopping playback temporarily

Press **▶/||** during playback.
The **||** indicator lights.

- To resume playback, press **▶/||**.

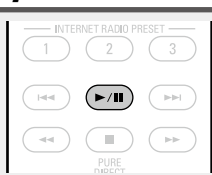

Fast-forwarding and Fast-reversing (searching)

During playback, press **⏮** or **⏭**.

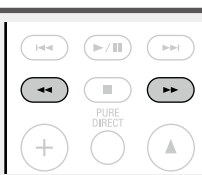

Stopping playback

Press **■** during playback.
Playback stops.

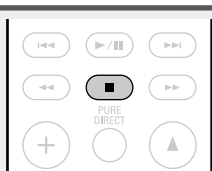

Switching the pure direct mode

In the stop mode, press **PURE DIRECT**.



- In pure direct mode, the unit is in the following state :

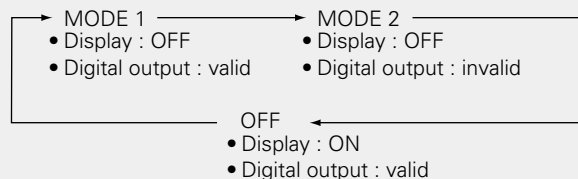

Moving to the beginning of tracks (skipping)

During playback, press **⏮** or **⏭**.

- The disc is skipped the number of tracks equal to the number of times the button is pressed.
- When pressed once in the return direction, playback returns to the beginning of the currently playing track.



Switching the display

Press **INFO**.

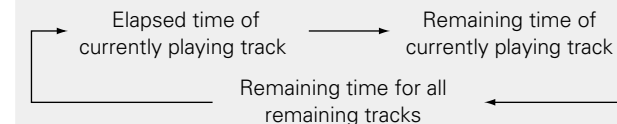

- The display switches each time the button is pressed.

Playing in random order (Random playback)

1 In the stop mode, press **RANDOM**.
The "RANDOM" indicator lights.

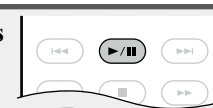

2 Press **▶/||**.
The tracks start playing in random order.

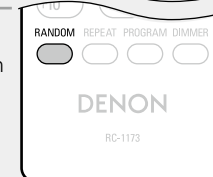

Resuming normal playback

In the stop mode, press **RANDOM**.
The "RANDOM" indicator turns off.



When **REPEAT** is pressed during random playback, the tracks are played in a different random order after this turn.

NOTE

Direct searching is not possible during random playback.

Playing repeatedly (Repeat playback)

Press REPEAT.

Playback in the respective repeat mode starts.



- The repeat mode changes each time the button is pressed.

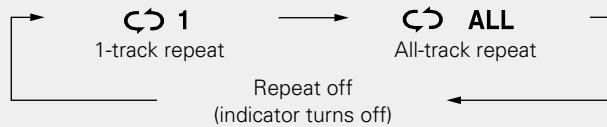

	Only 1 track is played repeatedly.
	All tracks are played repeatedly.
Repeat off	Normal playback resumes.

Playing tracks in a specific order (Program playback)

Up to 25 tracks can be programmed.

1 In the stop mode, press PROGRAM.

The "PGM" indicator lights.

2 Use 0 – 9 and +10 to select the tracks.

[Example]

To program tracks 3, 12, 7 to play in that order:

Press **3**, **+10**, **2** and **7**.

3 Press ►/II.

Playback starts in the programmed order.



To clear the last track programmed

While stopped, press **CLEAR**.

The last track programmed is cleared each time the button is pressed.

Clearing the all programmed track

In the stop mode, press **PROGRAM**.



- When **REPEAT** is pressed during program playback, the tracks are played repeatedly in the programmed order.
- When **RANDOM** is pressed during program playback, the programmed tracks are played in random order.

Switching the display's brightness

Press DIMMER.

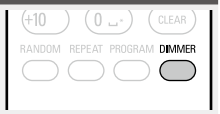

- The display's brightness switches each time the button is pressed.

Listening with headphones (DCD-720AE only)

Plug the headphones (sold separately) into the PHONES jack.

Adjusting the Volume

Turn **PHONES LEVEL** on the unit.

NOTE

To prevent hearing loss, do not raise volume level excessively when using headphones.

Using the timer play function

1 Turn on the power of the connected components.

2 Switch the amplifier's function to input from the connected unit.

3 Load a disc or connect an iPod or USB memory device.

4 Set the audio timer for the desired times.

• Refer also to the owner's manual of the audio timer.

5 Turn the timer "ON".



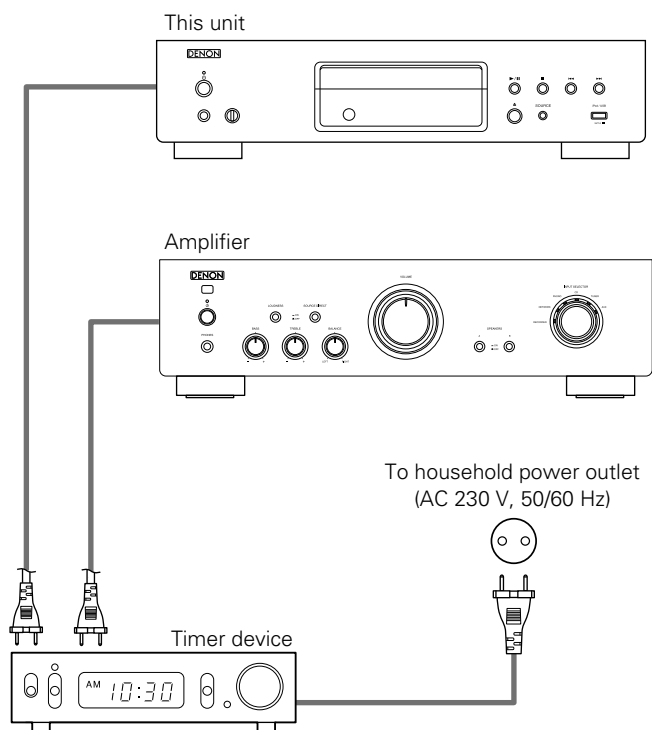

The power of the components connected to the timer turns off.

• When the set time is reached, the power of the different components automatically turns on and playback starts from the first track.



Information

Here, we list various information related to this unit.
Please refer to this information as needed.

- Part names and functions  [page 16](#)
- Other information  [page 21](#)
- Troubleshooting  [page 25](#)
- Specifications  [page 26](#)
- Index  [page 27](#)

Part names and functions

For buttons not explained here, see the page indicated in parentheses ().

Front panel

DCD-720AE

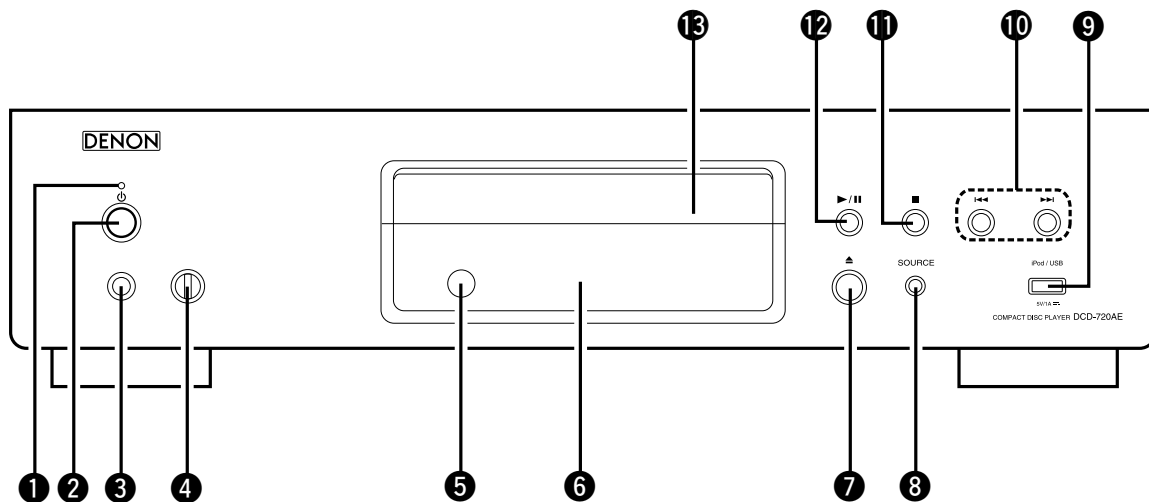

- 1 Power indicator** (8)
- [Power indicator status]**
 - Power on : Green
 - Normal standby : Red
 - Auto standby mode : Off
 - Charge mode standby : Orange
 - Power off : Off
- 2 Power operation button (⏻)** (8)
- 3 Headphones jack (PHONES)** (13)
- 4 Headphones volume control knob (PHONES LEVEL)** (13)
- 5 Remote control sensor** (20)
- 6 Display** (17)
- 7 Disc tray open/close button (⏏)** (8)
- 8 SOURCE button** (8, 11)
- 9 iPod/USB port** (5)
- 10 Reverse-skip/Forward-skip buttons (⏮, ⏭)** (9, 10, 11)
- 11 Stop button (■)** (10, 11)
- 12 Play/Pause button (▶/⏸)** (10, 11)
- 13 Disc tray**

DCD-520AE

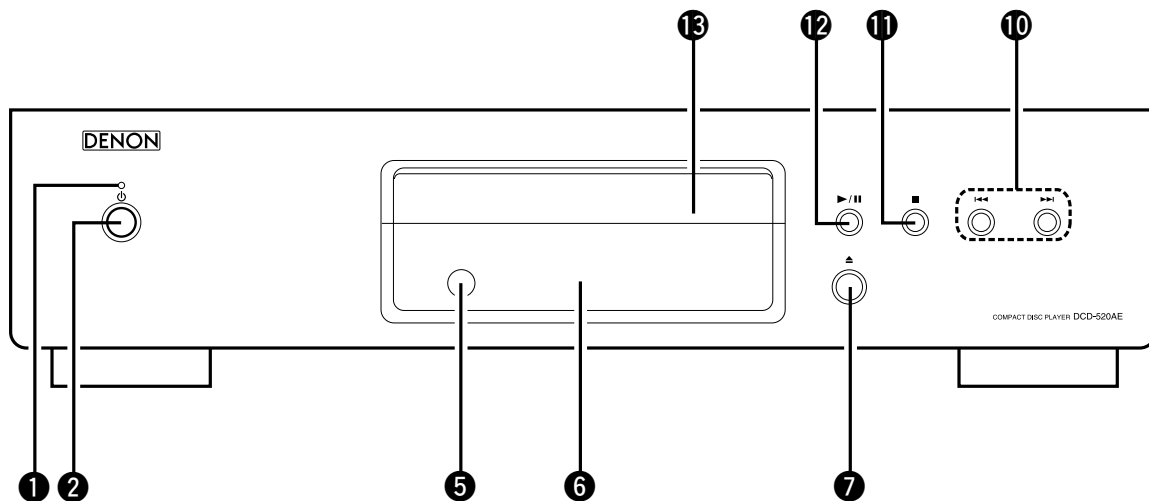

Display

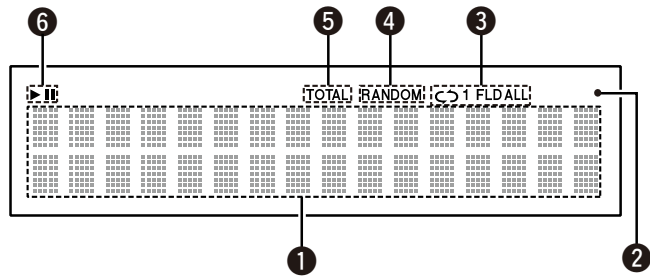

1 Information display

Displays various information or playback elapsed time and so on of the disc.

2 Remote control signal reception indicator

3 Repeat mode indicators

4 RANDOM indicator

5 TOTAL indicator

Lights when the total number of tracks and total time of the CD are displayed.

6 Playback mode indicators

- ▶ : During Playback
- || : During pause

Rear panel

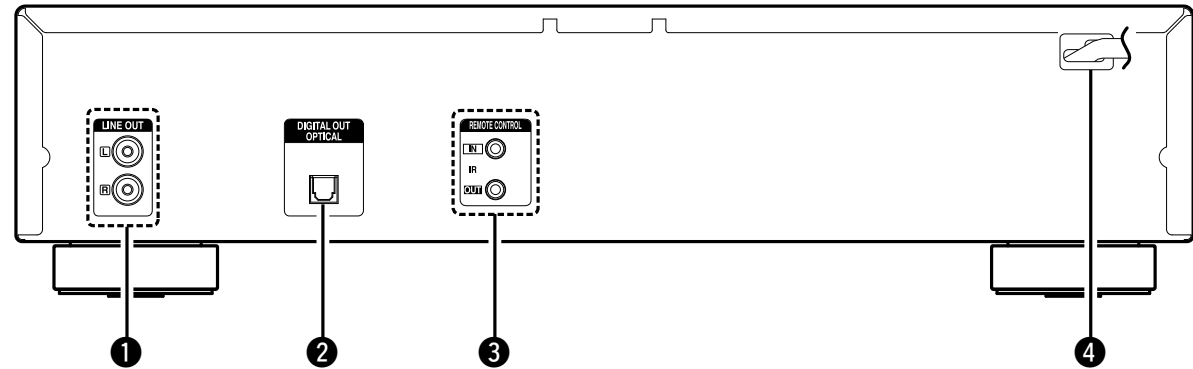

1 Analog audio connectors

(LINE OUT) (4)

2 Digital audio connectors

(DIGITAL OUT OPTICAL) (4)

3 REMOTE CONTROL jacks

Extension jack for future use.

4 Power cord

..... (6)

Remote control unit

For buttons not explained here, see the page indicated in parentheses ().

CD operation

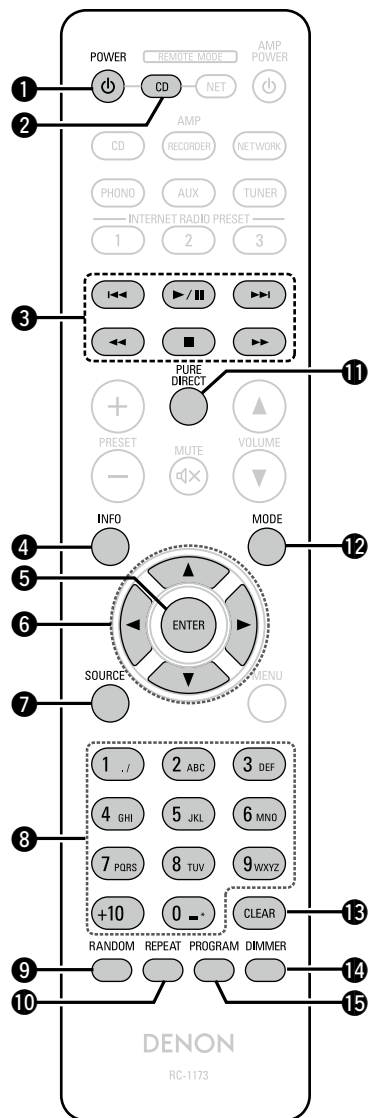

- ❶ **POWER button** (⏻) (6, 8)
- ❷ **REMOTE MODE buttons (CD)**
- ❸ **System buttons** (10, 11)
 - Skip buttons (⏮, ⏭)
 - Play/Pause button (▶/⏸)
 - Search buttons (⏪, ⏩)
 - Stop button (■)
- ❹ **Information button (INFO)** (12)
- ❺ **ENTER button** (9, 10, 11)
- ❻ **Cursor buttons (▲▼◀▶)** (9, 10, 11)
- ❼ **SOURCE button** (8, 11)
- ❽ **Number buttons** (8, 9, 10, 13)
- ❾ **RANDOM button** (10, 12, 13)
- ❿ **REPEAT button** (9, 10, 12, 13)
- ⓫ **PURE DIRECT button** (12)
- ⓬ **MODE button** (9, 10, 11)
- ⓭ **CLEAR button** (13)
- ⓮ **DIMMER button** (13)
- ⓯ **PROGRAM button** (13)

❑ Switching remote modes

To operate CD, press **CD** to switch the remote control to the CD operation mode.

- **CD** lights for approximately two seconds.



Operate the amplifier with the amplifier operation button even when the remote control operation mode is CD.

AMP operation

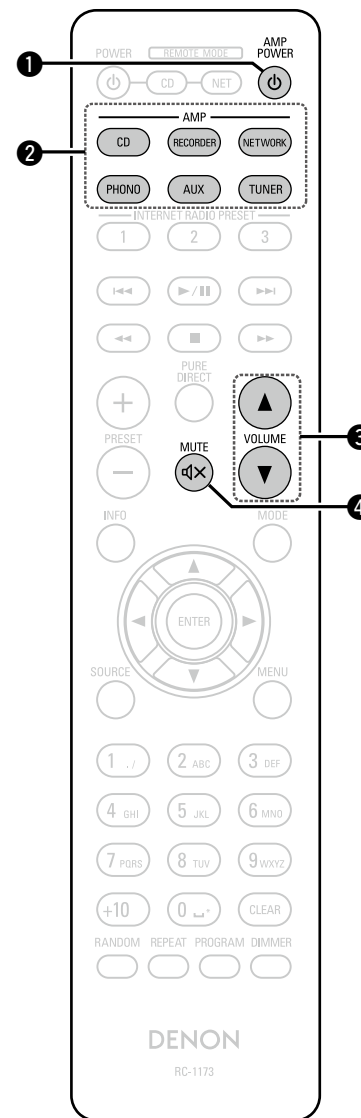

- ❶ **AMP POWER button** (⏻)
- ❷ **AMP buttons**
- ❸ **VOLUME buttons (▲▼)**
- ❹ **MUTE button** (⏻)

NETWORK operation

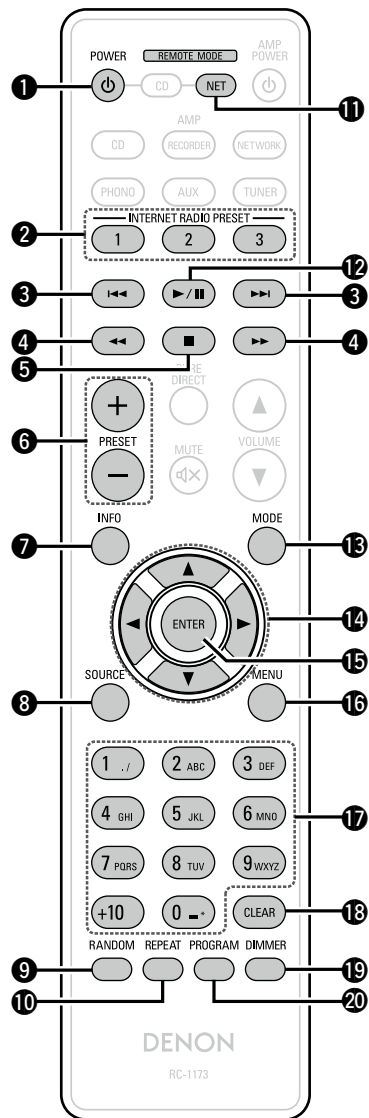

- ❶ POWER button (⏻)
- ❷ INTERNET RADIO STATION buttons (1 – 3)
- ❸ Reverse-skip/Forward-skip buttons (⏮, ⏭)
- ❹ Fast-reverse/Fast-forward buttons (⏪, ⏩)
- ❺ Stop button (■)
- ❻ PRESET buttons (+, -)
- ❼ Information button (INFO)
- ❽ SOURCE button
- ❾ RANDOM button
- ❿ REPEAT button
- ⓫ Remote mode select button (NET)
- ⓬ ▶/|| button
- ⓭ MODE button
- ⓮ Cursor buttons (⬆⬇⬅⬅)
- ⓯ ENTER button
- ⓰ MENU button
- ⓱ Number buttons (0 – 9, +10)
- ⓲ CLEAR button
- ⓳ DIMMER button
- ⓴ PROGRAM button

❑ Switching remote modes

To operate NETWORK, press **NET** to switch the remote control to the NETWORK operation mode.

- **NET** lights for approximately two seconds.



Operate the amplifier with the amplifier operation button even when the remote control operation mode is NETWORK.

Inserting the batteries

① Remove the rear lid in the direction of the arrow and remove it.

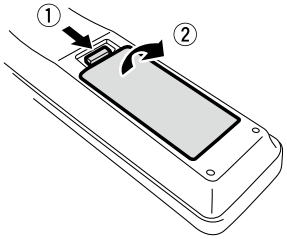

② Load the two batteries properly as indicated by the marks in the battery compartment.

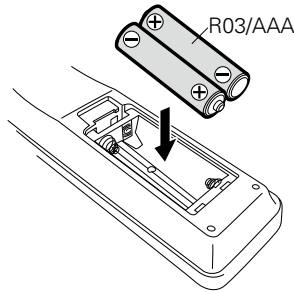

③ Put the rear cover back on.

NOTE

- Insert the specified batteries in the remote control unit.
- Replace the batteries with new ones if the set does not operate even when the remote control unit is operated close to the unit. (The supplied batteries are only for verifying operation. Replace them with new batteries at an early date.)
- When inserting the batteries, be sure to do so in the proper direction, following the \oplus and \ominus marks in the battery compartment.
- To prevent damage or leakage of battery fluid:
 - Do not use a new battery together with an old one.
 - Do not use two different types of batteries.
 - Do not attempt to charge dry batteries.
 - Do not short-circuit, disassemble, heat or dispose of batteries in flames.
 - Do not keep the battery in a place exposed to direct sunlight or in places with extremely high temperatures, such as near a heater.
- If the battery fluid should leak, carefully wipe the fluid off the inside of the battery compartment and insert new batteries.
- Remove the batteries from the remote control unit if it will not be in use for long periods.
- Used batteries should be disposed of in accordance with the local regulations regarding battery disposal.
- The remote control unit may function improperly if rechargeable batteries are used.

Operating range of the remote control unit

Point the remote control unit at the remote sensor when operating it.

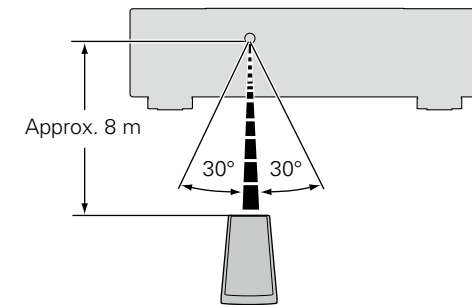



NOTE

The set may function improperly or the remote control unit may not operate if the remote control sensor is exposed to direct sunlight, strong artificial light from an inverter type fluorescent lamp or infrared light.

Other information

Playable media

Discs

Playable media	
CD	
CD-R*	
CD-RW*	

NOTE

- Some discs and some recording formats may not be playable.
- Non-finalized discs cannot be played.

Files

CD-R and CD-RW discs created in the format described below can be played.

Writing software format

ISO9660 level 1

- When written in other formats, it may not be possible to play the disc properly.

Maximum number of playable files and folders

Total number of folders and files : 512

Number of folders : 256

Tag data

ID3-Tags (Ver. 1.x and 2.x)

META-Tags (Compatible with title, artist and album names)

Playable files (Extension)	File specification
MP3 (.mp3)	<ul style="list-style-type: none"> • Sampling frequency : 32 / 44.1 / 48 kHz • Bit rate : 32 kbps to 320 kbps • Format : MPEG1 Audio Layer 3
WMA (.wma)	<ul style="list-style-type: none"> • Sampling frequency : 32 / 44.1 / 48 kHz • Bit rate : 64 kbps to 192 kbps • Format : Windows Media Audio

NOTE

- Be sure to give files the extension “.mp3” or “.wma”. Files with any other extensions or with no extensions cannot be played.
- Recordings you have made should only be used for your personal enjoyment, and as per copyright laws may not be used in other ways without permission of the copyright holder.

USB memory device

USB-Compatible file systems

FAT16 or FAT32

- If the USB memory device is divided into multiple partitions, only the top drive can be selected.

Maximum number of playable files and folders

Maximum number of files in a folder : 255

Maximum number of folders : 255

Tag data

ID3-Tags (Ver. 1.x and 2.x)

META-Tags (Compatible with title, artist and album names)

Playable files (Extension)	File specification
MP3 (.mp3)	<ul style="list-style-type: none"> • Sampling frequency : 32 / 44.1 / 48 kHz • Bit rate : 32 kbps to 320 kbps • Format : MPEG1 Audio Layer 3
WMA (.wma)	<ul style="list-style-type: none"> • Sampling frequency : 32 / 44.1 / 48 kHz • Bit rate : 64 kbps to 192 kbps • Format : Windows Media Audio



Only music files that are not copyright-protected can be played on this set.

- Contents downloaded from pay sites on the Internet are copyright protected. Also, files encoded in WMA format when ripped from a CD, etc., on a computer may be copyright protected, depending on the computer's settings.

NOTE

- Insert and remove a USB memory device with the power set to standby. If it is inserted or removed with the power on, the recorded files cannot be loaded or may be damaged.
- It is not compatible with an MP3 player, digital camera, a USB device for a mobile phone, etc.
- The unit cannot charge a USB device.
- The unit does not support a card reader, USB extension cable, or USB hub.

MP3 or WMA playback order of MP3 or WMA files

When there are multiple folders containing MP3 or WMA files, the playback order of folders is automatically set when this unit reads the media. The files in each folder are played back in the order in which the files were recorded on the media, from the oldest date and time.

CD-R/CD-RW

For playback of files on CD-R or CD-RW, files in all folders on the first layer are played first, next on the second layer, then next on the third layer, and so on in this order.

USB memory device

For playback of files recorded on USB, files in the first folder on the first layer are played first, next folders on the second layer in the folder, then next on the third layer, and so on in this order. Then accordingly files on another first layer are played.



- The playback order displayed on a PC may differ from the actual playback order.
- The playback order with a CD-R/CD-RW may differ, depending on the writing software.

NOTE

- The playback order may differ from the order in which the folders or files were recorded if you delete or add a folder or file on USB. This occurs because of data recording specifications and is not a malfunction.

About Discs and Files

Files, such as MP3/WMA etc., recorded on CD-R/RW and USB memory device are divided into large segments (folders) and small segments (files). Files are stored in folders, and folders can be placed for storage in a hierarchy. The unit can recognize up to 8 levels of folders.

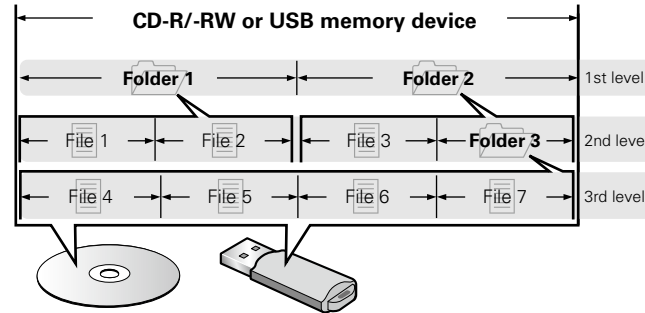

When writing MP3/WMA etc. files on a CD-R/RW disc, set the writing software's format to "ISO9660". The files may not play properly if they are recorded in other formats. For details, refer to the instructions of your writing software.

Cautions on using media

Inserting a disc

- Set the disc in the tray label side up.
- Make sure the disc tray is fully open when inserting the disc.
- Place the disc horizontally in the tray, aligned with the tray guide.



- "00 Tr 00 : 00" is displayed if a disc that cannot be played is loaded.
- "NO DISC" is displayed if the disc is loaded upside-down or if no disc is loaded.

NOTE

- Only load one disc at a time. Loading two or more discs can damage the unit or scratch the discs.
- Do not use cracked or warped discs or discs that have been repaired with adhesive, etc.
- Do not use discs on which the sticky part of cellophane tape or labels is exposed or on which there are traces of where labels have been removed. Such discs can get caught inside the player and damage it.
- Do not use discs in special shapes, as they may damage the player.

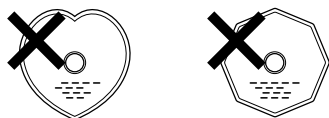

- Do not push the disc tray in by hand when the power is off. Doing so could damage the set.

How to handle media

- Do not get fingerprints, oil or dirt on discs.
- Take special care not to scratch discs when removing them from their cases.
- Do not bend or heat discs.
- Do not enlarge the hole in the center.
- Do not write on the labeled (printed) surface with ball-point pens, pencils, etc., or stick new labels on discs.
- Condensation may form on discs if they are moved suddenly from a cold place (outdoors for example) to a warm place, but do not try to dry discs with a hairdryer, etc.
- Do not eject a USB memory device or turn off the unit while a USB memory device is being played. This may result in malfunction or loss of the USB memory device's data.
- Do not attempt to open or modify USB memory device.
- USB memory device and files can be damaged by static electricity. Do not touch the metal contacts of an USB memory device with your fingers.
- Do not use warped USB memory device.
- After use, be sure to remove any disc or USB memory device, and store it in its proper case, to avoid dust, scratches and deformation.
- Do not store discs in the following places:
 1. Places exposed to direct sunlight for long periods of time
 2. Dusty or humid places
 3. Places exposed to heat from heaters, etc.

Cleaning discs

- If there are fingerprints or dirt on a disc, wipe them off before using the disc.
- Use a commercially available disc cleaning set or a soft cloth to clean discs.

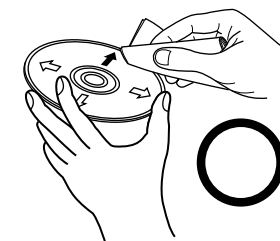

Gently wipe the disc from the inside towards the outside.



Do not wipe with a circular motion.

NOTE

Do not use record spray, antistatic agents, benzene, thinner or other solvents.

Explanation of terms

A

AL32 Processing

AL32 Processing for All Channels.

DENON has further developed its proprietary AL32 Processing, an analog waveform reproduction technology. AL32 Processing, thoroughly suppresses quantization noise associated with D/A conversion of LPCM signals to reproduce the lowlevel signals with optimum clarity that will bring out all the delicate nuances of the music.

B

Bit rate

This is the amount of or audio data recorded on a disc that is read in one second.

D

Dynamic range

The difference between the maximum, undistorted sound level and the minimum sound level that is discernible above the noise emitted by the device.

F

Finalizing

This process enables CD recorded with a recorder to be played by other players.

L

Linear PCM

This is an uncompressed PCM (Pulse Code Modulation) signal. This is the same system as the CD audio but uses 192 kHz, 96 kHz, and 48 kHz sampling frequencies on BD or DVD and provides higher sound quality than CD.

M

MP3 (MPEG AudioPlayer 3)

This is an internationally standardized audio data compression scheme, using the "MPEG-1" video compression standard. It compresses the data volume to about one eleventh its original size while maintaining sound quality equivalent to a music CD.

P

Pure direct

This function enables higher-quality playback of audio signals, by turning off the display and digital output to eliminate any slight effect they may have on the audio circuits.

S

Sampling frequency

Sampling involves taking a reading of a sound wave (analog signal) at regular intervals and expressing the height of the wave at each reading in digitized format (producing a digital signal).

The number of readings taken in one second is called the "sampling frequency". The larger the value, the closer the reproduced sound is to the original.

W

WMA (Windows Media Audio)

This is audio compression technology developed by Microsoft Corporation.

To encode WMA files, only use applications authorized by Microsoft Corporation. If you use an unauthorized application, the file may not work properly.

Troubleshooting

If a problem should arise, first check the following:

1. Are the connections correct?

2. Is the set being operated as described in the owner's manual?



3. Are the other devices operating properly?

If this unit does not operate properly, check the items listed in the table below. Should the problem persist, there may be a malfunction.

In this case, disconnect the power immediately and contact your store of purchase.

[General]

Symptom	Cause	Countermeasure	Page
Disc tray does not open.	• The power is not on.	• Turn on the power.	8
"NO DISC" is displayed even though a disc is loaded.	• The disc is not properly loaded.	• Reload the disc.	23
"TRACK 0 0m00s" is displayed even though a disc is loaded.	• The loaded disc is not a CD.	• Load a CD.	23
Playback does not start even when the  button is pressed.	• The disc is dirty or scratched.	• Wipe the dirt off the disc or replace the disc.	23
No sound is produced or sound is distorted.	• The output cables are not properly connected to the amplifier. • The amplifier's function setting or adjustments are not right.	• Check the connections. • Check the amplifier's functions and controls and adjust as necessary.	4 , 5 , 6 –
A specific section of a disc does not play properly.	• The disc is dirty or scratched.	• Wipe the dirt off the disc or replace the disc.	23

Symptom	Cause	Countermeasure	Page
Programmed playback is not possible.	• The tracks have not been programmed properly. • Programmed playback is not possible with MP3 and WMA files.	• Program properly. • Use a CD.	9 9
A CD-R or CD-RW disc cannot be played.	• The disc has not been finalized. • The recording conditions and/or the quality of the disc itself are poor.	• Finalize the disc then play it. • Use a properly recorded disc.	23 23
The unit does not operate properly when the remote control unit is operated.	• The batteries are dead. • The remote control unit is too far from the unit.	• Replace the batteries with new ones. • Move the remote control unit closer to the unit.	20 20
File recorded in MP3 or WMA formats cannot be played.	• You have selected a copyright-protected WMA file or a file that cannot be played normally.	• Use the   button on the remote control unit to select a different file.	9

[iPod]

Symptom	Cause	Countermeasure	Page
The iPod cannot be played.	• Cable is not properly connected.	• Reconnect.	5

[USB memory device]

Symptom	Cause	Countermeasure	Page
When a USB memory device is connected, "NO DEVICE" is displayed.	<ul style="list-style-type: none"> The unit cannot recognize a USB memory device. A USB memory device not conforming to mass storage class or MTP standards is connected. A USB memory device that the unit cannot recognize is connected. The USB memory device is connected via USB hub. 	<ul style="list-style-type: none"> Check the connection. Connect a USB memory device conforming to mass storage class or MTP standards. This is not a malfunction. DENON does not guarantee that all USB memory devices will operate or receive power. Connect the USB memory device directly to the USB port. 	5
Files on a USB memory device cannot be played.	<ul style="list-style-type: none"> The USB memory device is in a format other than FAT16 or FAT32. The USB memory device is divided into multiple partitions. 	<ul style="list-style-type: none"> Set the format to FAT16 or FAT32. For details, refer to the USB memory device's operating instructions. 	–
		<ul style="list-style-type: none"> When divided into multiple partitions, only files stored in the top partition can be played. 	–
	<ul style="list-style-type: none"> Files are stored in a non-compatible format. 	<ul style="list-style-type: none"> Record the files in a compatible format. 	21
	<ul style="list-style-type: none"> You are attempting to play a file that is copyright protected. 	<ul style="list-style-type: none"> Files that are copyright protected cannot be played on this unit. 	21

Specifications

	[DCD-720AE]	[DCD-520AE]
Audio performance		
• Analog output		
Channels:	2 channels	2 channels
Playable frequency range:	2 Hz – 20 kHz	2 Hz – 20 kHz
Playable frequency response:	2 Hz – 20 kHz	2 Hz – 20 kHz
S/N:	112 dB	110 dB
Dynamic range:	100 dB	100 dB
Harmonic distortion:	0.0025 % (1 kHz)	0.003 % (1 kHz)
Wow & flutter:	Below measurable limits	Below measurable limits
Output level:	2.0 V (10 kΩ)	2.0 V (10 kΩ)
Signal type:	16-bit linear PCM	16-bit linear PCM
Sampling frequency:	44.1 kHz	44.1 kHz
Usable discs:	Compact Disc	Compact Disc
• Digital output		
Optical:	–15 – –21 dBm	–15 – –21 dBm
Emission wavelength:	660 nm	660 nm
General		
Power supply:	AC 230 V, 50/60 Hz	AC 230 V, 50/60 Hz
Power consumption:	22 W	13 W
Power consumption in standby mode:	0.3 W	0.3 W

For purposes of improvement, specifications and design are subject to change without notice.

Index

A

Accessories 1
AL32 Processing 24
All-track repeat 9, 13

B

Batteries 20
Bit rate 21, 24
Brightness 13

C

Cable
 Audio cable 4
 Optical cable 4
 USB cable 4
Cables used for connections 4
CD 21
CD-R/-RW 21, 22
Condensation 2
Connection
 Amplifier 4
 CD recorder 4
 iPod 5
 MD recorder 4
 Power cord 6
 USB memory device 5

D

Display 17
Dynamic range 24

E

Extension 21

F

Fast-forwarding 12
Fast-reversing 12
File 21
Finalizing 24
Folder 22
Folder mode 9, 11
Front Panel 16

H

Headphones 13, 16

I

iPod 10

L

Linear PCM 24

M

MP3 9, 21, 24

O

Operation
 Fast-forward/fast-reverse 12
 Pause 12
 Program 13
 Pure direct 12
 Random 12
 Repeat 13
 Skip 12
 Stop 12

P

Pause 12
Playback
 CD 8
 iPod 10
 MP3 9
 USB memory device 11
 WMA 9
Power cord 6
Pure direct 12, 24

R

Random playback 12
Rear panel 17
Remote control unit 18
 Inserting the batteries 20
Repeat playback 9, 13

S

Sampling frequency 21, 24
Searching 12
Single-track repeat 9
Skipping 12
Stop 12
Switching the display 12

T

Timer play function 14
Troubleshooting 25

U

USB memory device 11, 21, 22

W

WMA 9, 21, 24

Dimensions

Unit : mm

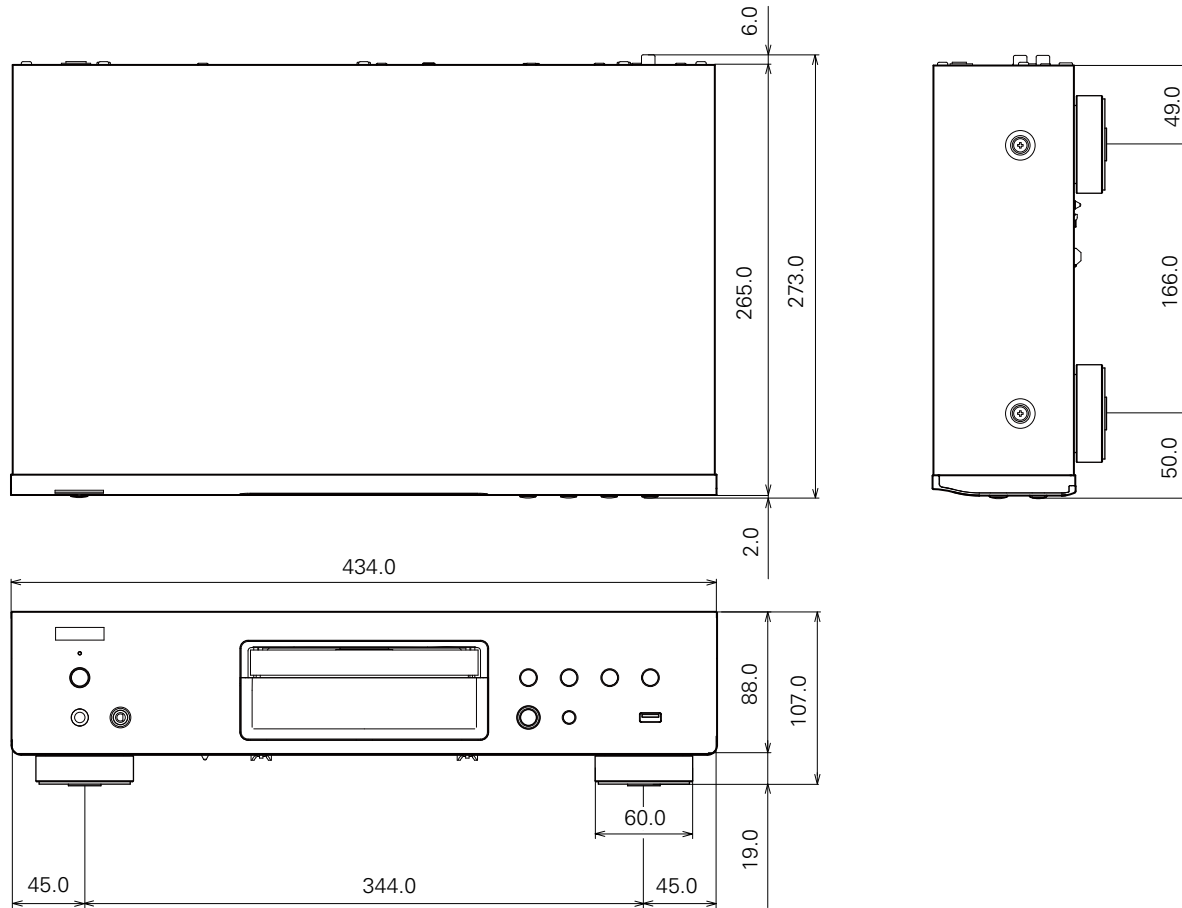

Weight : DCD-720AE: 4.1 kg
DCD-520AE: 4.0 kg

